

USB Starter Kit AMS 6915

User Guide

USB Starter Kit AMS 6915

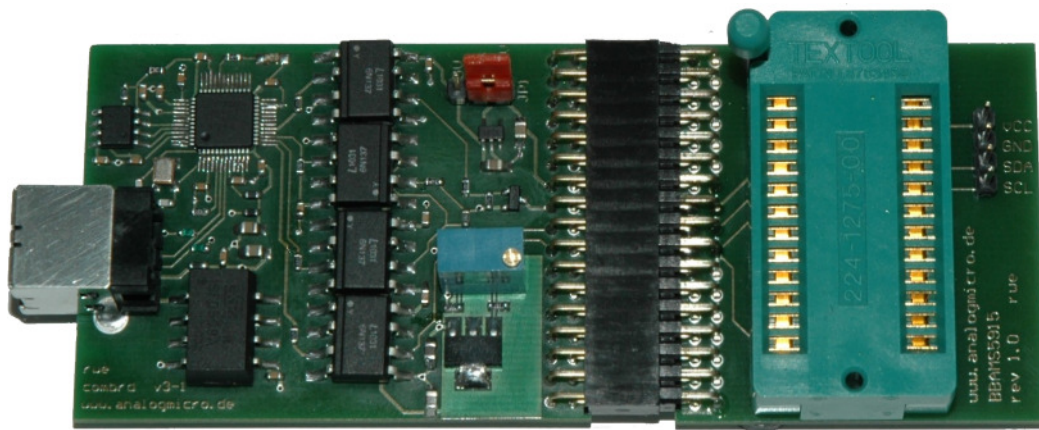

analog microelectronics

Analog Microelectronics GmbH
An der Fahrt 13, D – 55124 Mainz

Phone: +49 (0)6131/91 073-0
Fax: +49 (0)6131/91 073-30
Internet: www.analogmicro.de
E-Mail: info@analogmicro.de

Oct. 2017 Rev. 1.0

USB Starter Kit AMS 6915

CONTENTS

INTRODUCTION	3
HARDWARE	3
SOFTWARE – <i>CS6915</i>	5
INSTALLATION	5
CS6915 USER INTERFACE	5
INITIAL OPERATION	9
IMPORTANT NOTES	10
ADDITIONAL EQUIPMENT	10
ADDITIONAL DOCUMENTS	10

USB Starter Kit AMS 6915

INTRODUCTION

The USB Starter Kit AMS 6915 is designed for quick and easy initial operation of AMS 6915 pressure sensors with a standard PC with Windows operating system. Without additional components, the kit enables current digital pressure and temperature values to be read out via the I2C sensor interface and to be displayed on the PC.

In addition the starter kit can be used to program an individual I2C address into each AMS 6915 pressure sensor. This customized I2C address is prerequisite for the operation of several AMS 6915 pressure sensors together on one I2C bus.

The starter kit consists of two printed circuit boards and the relevant communication software package CS6915 distributed on the starter kit CD. A Windows PC with an USB port and with operating system XP SP3 or above is required for operation. The kit will be supplied by the USB port, an external supply isn't necessary.

NB: We recommend that you read the AMS 6915 sensor datasheet before putting the starter kit into operation.

Hardware

The starter kit hardware consists of two printed circuit boards: the communication board *CB-I2C* and the adapter board *BB5915/BB6915* with a ZIF-socket to connect one AMS 6915 sensor. Figure 1 shows the assembled kit with mounted sensor.

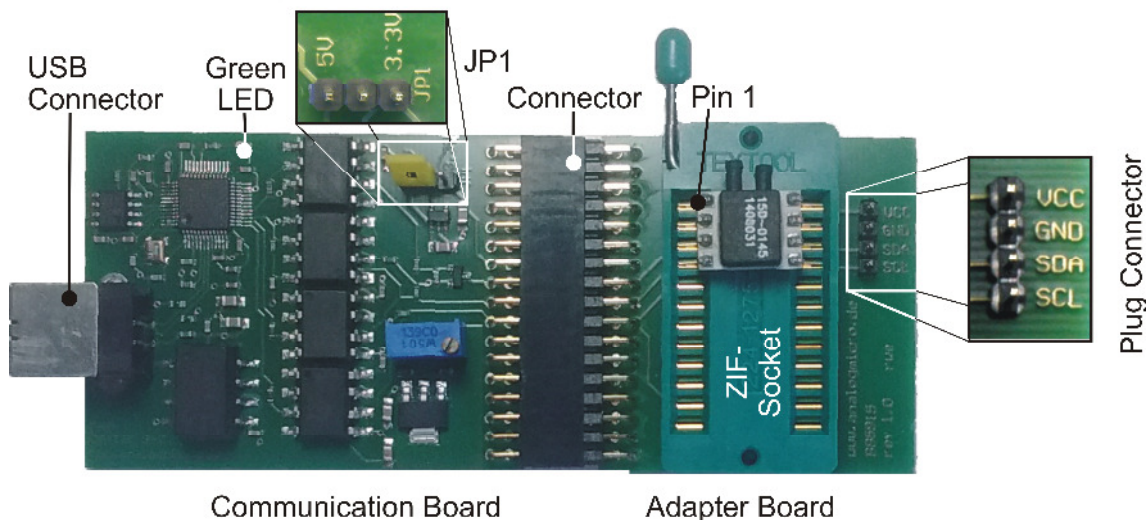

Figure 1: USB Starter Kit AMS 6915 with connected sensor.

The kit consists of a communication board CB-I2C and an adapter board BB5915/BB6915, connected by a 34-pin connector.

USB Starter Kit AMS 6915

The *CB-I2C* printing circuit board provides the hardware which enables a PC with USB-2.0 port to communicate with a pressure sensor with I2C interface. The *BB5915/BB6915* printed circuit board provides an easy way to connect an AMS 6915 pressure sensor with the *CB-I2C*. Both printed circuit boards are connected by a 34 pin connector.

Using a standard USB cable the USB jack on the *CB-I2C* is connected to a free USB-port at the PC. The PC's USB-port is used for communication and for power supply of the starter kit and the connected pressure sensor; an additional supply isn't required.

The connection between *CB-I2C* and *BB5915/BB6915* is realised by a 34 pin connector. A zero injection force (ZIF) socket on the *BB5915/BB6915* allows easy mounting and exchanging of an AMS 6915 pressure sensor. Pin 1 of the sensor is at the upper left edge of the ZIF-Socket (see Figure 1).

The sensor voltage can be chosen between 3.3V and 5V by jumper JP1 on *CB-I2C* (see Figure 1); for standard products of the AMS 6915 series JP1 is connected to 3.3V. Further, for exchanging the mounted AMS 6915 the sensor voltage supply can be turned off by removing JP1.

At the 4 pin plug connector on the *BB5915/BB6915* the sensor voltage supply VCC, GND and the I2C bus lines are connected. This plug can be used for monitoring the sensor supply voltage and further for connecting and testing sensors, which are already assembled.

For safety in case of failure an electrical isolation between the sensor and the PC was realised on the *CB-I2C*. This avoids effectively an energy flow into the connected PC.

Table 1: Configuration of Jumper JP1 on CB-I2C

Sensor voltage	Jumper position JP1
internal 3,3 V	central pin together with pin 3.3V
internal 5 V	central pin together with pin 5V
external supply	removed
turned off	removed

Important:

1. If an AMS 6915 sensor is connected to the 4-pin plug connector on the *BB5915/BB6915*, the sensor has to be supplied by the starter kit to provide the full functionality of the starter kit software.
2. If it isn't possible to supply the sensor by the starter kit, the jumper JP1 on the *CB-I2C* has to be removed and the external power supply has to be connected to VCC-pin at the 4 pin plug connector on the *BB5915/BB6915*. In this case, a change of the I2C address isn't possible.
3. If JP1 isn't removed in case of an external sensor power supply at pin VCC, the starter kit can be damaged!

USB Starter Kit AMS 6915

Software – CS6915

The communication between the PC and the AMS 6915 pressure sensor (mounted onto the starter kit) is realised by means of the software package *CS6915*. This software is provided on the starter kit CD and runs under Windows operating systems (XP SP3 or above).

Installation

Before installation of the software package *CS6915*, please disconnect starter kit. By executing the file *CS6915_Setup.exe* on the CD-ROM (must be run as an administrator), an installer is started which guides through the installation process. After the installation process is finished, the necessary files for operating the starter kit are copied to the target directory and the needed drivers are installed, too. The starter kit is now ready to use and can be connected to the PC.

CS6915 user interface

The software *CS6915* is run via the “AMS 6915” icon in the program group “AMS 6915” in the folder programs in the windows start menu.

The user interface (menu) is shown in Figure 2. The menu is divided in three submenus: “Communication Check”, “Measurement” und “Change I2C Address” which are designed as index sheets. They will be described in detail below.

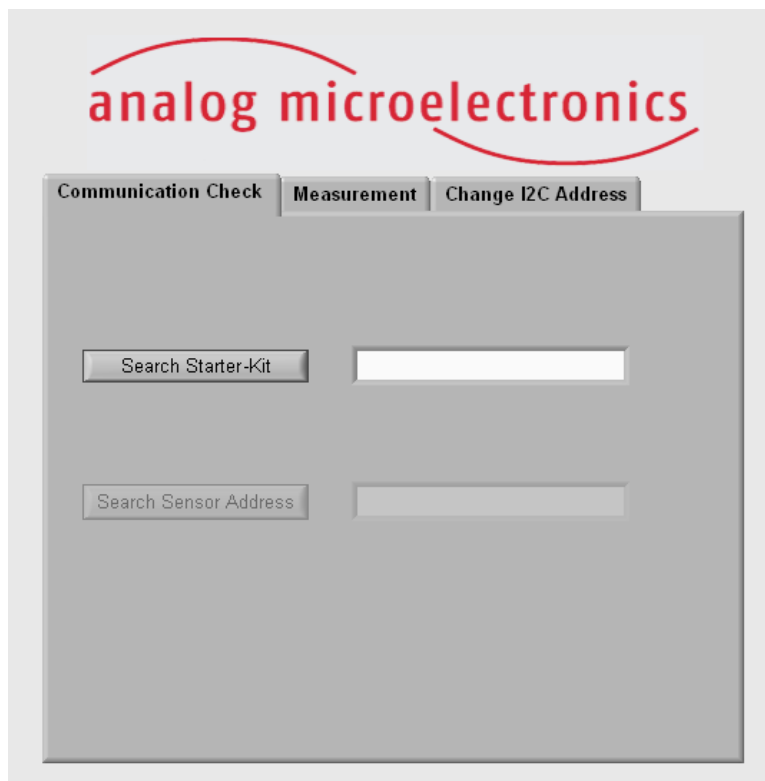

Figure 2: CS6915 user interface

USB Starter Kit AMS 6915

Submenu “Communication Check”

The submenu “Communication Check” is to establish and test the connection between the PC and the AMS 6915 pressure sensor mounted onto the starter kit. By pushing the button “Search Starter Kit” (see Figure 3 left) the link connection between the PC and the starter kit will be initiated. If it's successful (message: “Found Starter Kit”), the starter kit will be ready to use. Now, a connection to the AMS 6915 pressure sensor (mounted onto the starter kit) can be established. By pushing the button “Search Sensor Address”, the software searches for an AMS 6915 sensor with a valid I2C address. A message follows, whether a corresponding sensor was found or not. Figure 3 right shows an example of a sensor with the I2C address 11_{hex}.

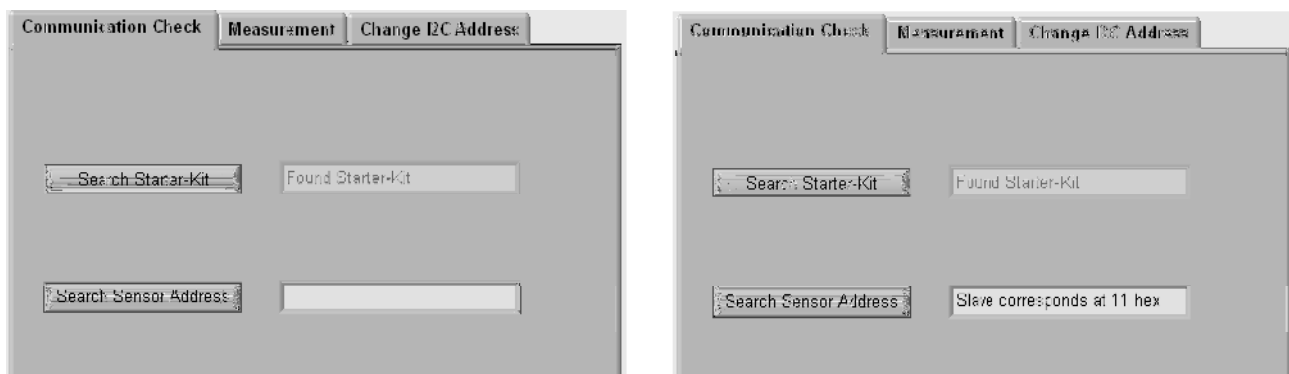

Figure 3: Submenu “Communication Check”.

Left: A connection to the starter kit was established. Right: A sensor with the address 11_{hex} was found.

After a successful initialisation of the connected starter kit, the remaining submenus will be enabled.

Note: If no starter kit was found after pushing the button “Search Starter Kit” please follow the tips given in section *Initial Operation* paragraph 4. In case of the error message “No slave was found” is displayed (after pushing the button “Search Sensor”) please check the following: the connection of the two PCBs, the position of JP1, the position of the AMS 6915 in the ZIF socket and the locking of the ZIF-socket.

Submenu “Measurement”

The submenu “Measurement” is divided in a configuration and a measurement part (see Figure 4). In the configuration part, the correct AMS 6915 sensor type (mounted onto or connected to the starter kit) has to be chosen by a drop down menu. In the measurement part, the read out measurement values for pressure and temperature are displayed in digital units and in calculated physical units.

USB Starter Kit AMS 6915

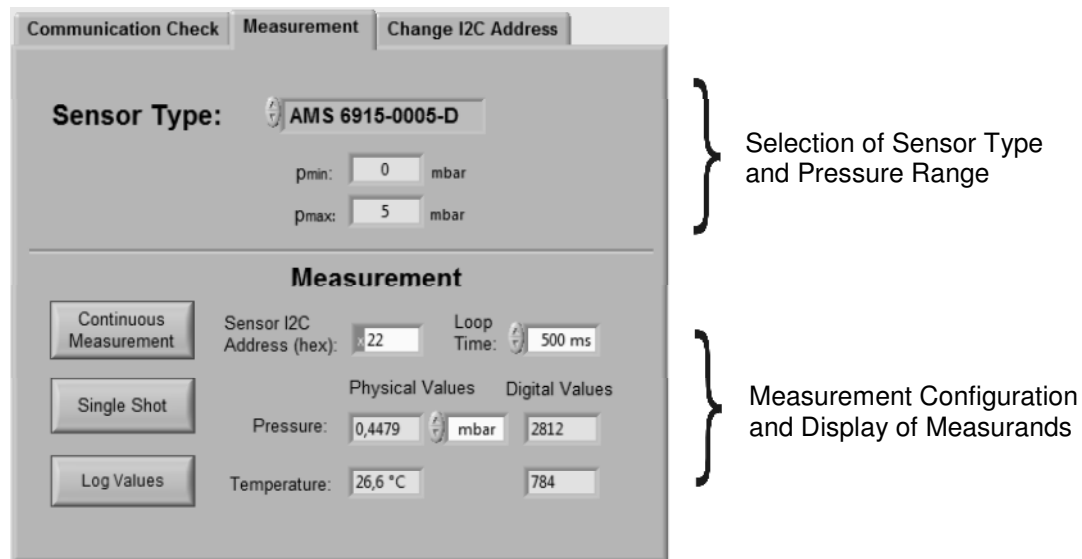

Figure 4: View of the submenu “Measurement”.

The submenu is divided in a configuration area (top) and a measurement area, where the measured values are displayed (bottom).

Configuration area:

With the drop down menu “Sensor Type”, the exact AMS 6915 sensor type connected to the starter kit has to be selected with its exact ordering code (e.g.: AMS 6915-0005-D) (see Figure 5 left). For the selected type the sensor pressure range is shown below. In case of a custom specific version or a sensor which is not in the menu, the sensor type “customised” has to be selected. In that case the specified minimal and maximal pressure values p_{\min} and p_{\max} have to be filled into the adequate fields below (as shown in Figure 5 right).



Figure 5: Selection of the used AMS 6915 sensor type.

Left: A sensor type AMS 6915-0005-D with a measuring range of 0- 5 mbar was selected. Right: A customised sensor with a manually adjusted pressure range from -200 mbar up to 400 mbar was selected.

NB: If the wrong sensor type is selected, sensor measurement data cannot be accurately evaluated and the displayed pressure value in physical units is wrong!

USB Starter Kit AMS 6915

Measurement area:

The measurement area is shown in Figure 6. Before starting a measurement, the I2C address of the connected sensor has to be filled in the field "Sensor I2C Address (hex)". This field displays by default the value detected during the last scan in submenu "Communication Check".

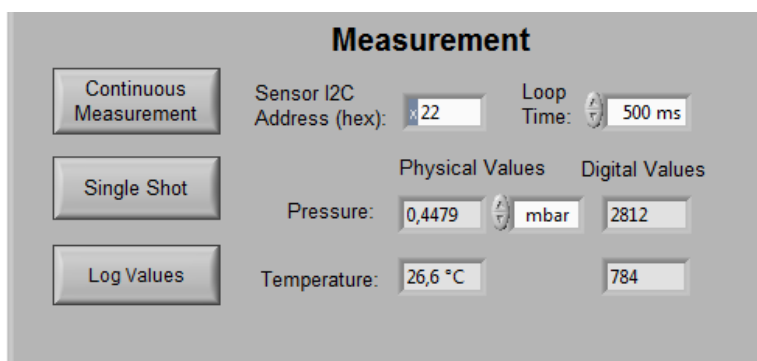

Figure 6: View on area "Measurement"

With the buttons "Continuous Measurement" and "Single Shot" on the left side, a continuous or a single measurement can be started. In case of a continuous measurement, the time interval between the discrete measurements can be selected by the drop down menu "Loop Time" on the right side. The continuous measurement can be stopped by pushing the button "Continuous Measurement" again.

In general 4 data bytes are read from the sensors output register and converted to decimal values in pairs: the first and second data bytes generate the decimal pressure and the third and fourth the decimal temperature value. The current readout pressure and temperature data are displayed as digital (decimal) values and also as values in physical units. The latter are calculated with the formula described in the data sheet of AMS 6915 sensor series. The physical pressure unit can be selected by a drop down menu at the right side of the displayed pressure.

For a single measurement "Single Shot" the current measurement data available at the AMS 6915 output register is one-time read and continuously displayed. In case of the continuous measurement the measurement data is repeatedly read out and displayed. By pushing the button "Log Values" at the left lower edge, the readout digital values can be saved in a file. At the first time values have to be written, a windows dialog appears to assign the file name and the folder to save in. The file includes only the digital values.

Submenu "Change I2C Address"

In the submenu "Change I2C Address" (see Figure 7) an individual I2C address can be programmed into the connected AMS 6915 pressure sensor. The box "Current I2C Address" displays by default the hex address value detected during the last scan in submenu "Communication Check", which is the current I2C address of the connected sensor. The new I2C address (between 00_{hex} and 7F_{hex}) has to be written in the box "New I2C Address" as a hexadecimal value. By pushing the button "Change I2C Address", the new I2C address will be programmed to the AMS 6915 EEPROM. Subsequent, the new I2C address will be checked by changing to submenu "Communication Check" and run a sensor search. The result will be displayed.

USB Starter Kit AMS 6915

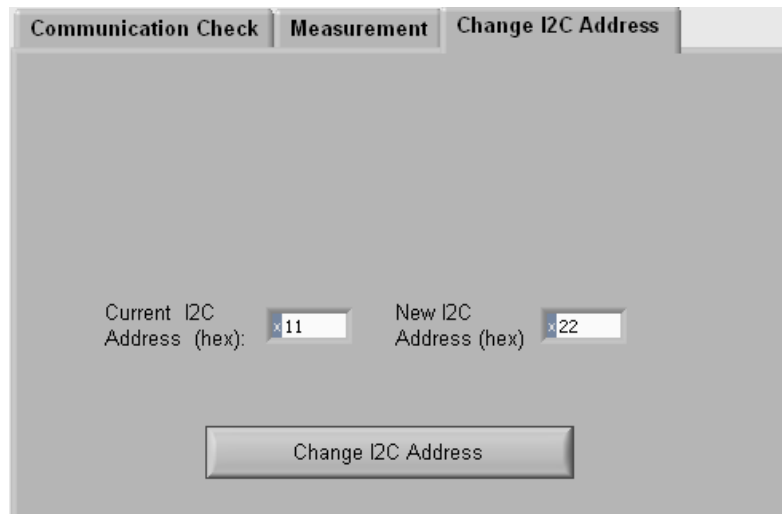

Figure 7: Submenu “Change I2C Address” for changing the I2C sensor address.

NB: If several AMS 6915 sensors are to be operated together on one I2C bus, each sensor must first be allocated its own individual I2C address.

INITIAL OPERATION

The following steps are necessary for the starter kit initial operation:

1. Installation of the Software *CS6915* (see section software)
2. Assembly starter kit

First, the adapter board *BB5915/BB6915* for AMS 6915 sensor and the communication board *CB-I2C* are connected together by the 34 pin connector. Then, the AMS 6915 sensor has to be mounted into the ZIF socket on *BB5915/BB6915* (orientation of pin 1: see Figure 1). The sensor supply voltage has to be set to 3.3 V with JP1 on the communication board *CB-I2C* (for standard AMS 6915 pressure sensors).

3. Connect the starter kit to a free USB port at the PC by an USB cable.
4. The green LED on the communication board flashes up, when the board is detected by the PC and the drivers are loaded successfully (see Figure 1).

If the green LED remains dark, the user has to look in the device manager for a new device called “USB Serial Converter” in the device group “USB-Controller”. If this doesn’t exist, the user has to disconnect the starter kit from the PC by removing the USB-cable. At a reconnection, the device “USB Serial Converter” should appear. If not, the problem could be solved by manually executing the file *Treiber_Setup.exe* in the program folder of the AMS 6915 Software (e.g.: C:\program files\AMS 6915). If the led remains still dark and the starter kit wasn’t found, contact Analog Microelectronics for further support.

USB Starter Kit AMS 6915

IMPORTANT NOTES

1. For changing an AMS 6915 pressure sensor while the communication board is connected to the PC, we recommend to remove the jumper JP1. It prevents sensor damage.
2. If the sensor is supplied externally, the jumper JP1 has to be removed and the external power supply has to be connected to pin VCC at the 4 pin plug connector. However, in this operation mode a change of the sensor I2C address is impossible.
3. The communication Board *CB-I2C* can be used for read out pressure sensors of the series AMS 5105 and AMS 5812, too. For starting up, only the corresponding adapter boards *BB5105* respectively *BB5812* and the according software *CS5105* respectively *CS5812* are necessary.

ADDITIONAL EQUIPMENT

- USB-cable 2.0, FullSpeed A-St to B-St .

ADDITIONAL DOCUMENTS

- Data Sheet of AMS 6915 Pressure Sensor Series

Analog Microelectronics GmbH reserves the right to amend any dimensions, technical data or other information contained herein without prior notification.